



INTELLECTUAL
PROPERTY OFFICE

**Printed list of Registered Designs as shown in the
Registered Designs Journal No 6385 published
05 October 2011**

4021277

Grant Date 09 September 2011



Design Text:

Aluminium rainwater diverter

Proprietor:

Dales Fabrications Limited

Agent:Dales Fabrications Limited

Registration Date: 13 August 2011

LOC (07) Cl. 23-01

4021295

Grant Date 09 September 2011

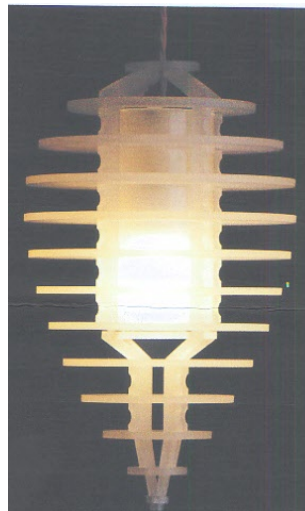

Design Text:

Tear pendant light

Proprietor:

Jonathan Hopper

Agent:Jonathan Hopper

Registration Date: 17 August 2011

LOC (07) Cl. 26-05

4021294

Grant Date 09 September 2011



Design Text:

Cube pendant light

Proprietor:

Jonathan Hopper

Agent:Jonathan Hopper

Registration Date: 17 August 2011

LOC (07) Cl. 26-05

4021296

Grant Date 09 September 2011



Design Text:

Tool for power tools

Proprietor:

Armeg Ltd

Agent:Russell Adam Lintin

Registration Date: 17 August 2011

LOC (07) Cl. 08-01

4021313

Grant Date 09 September 2011

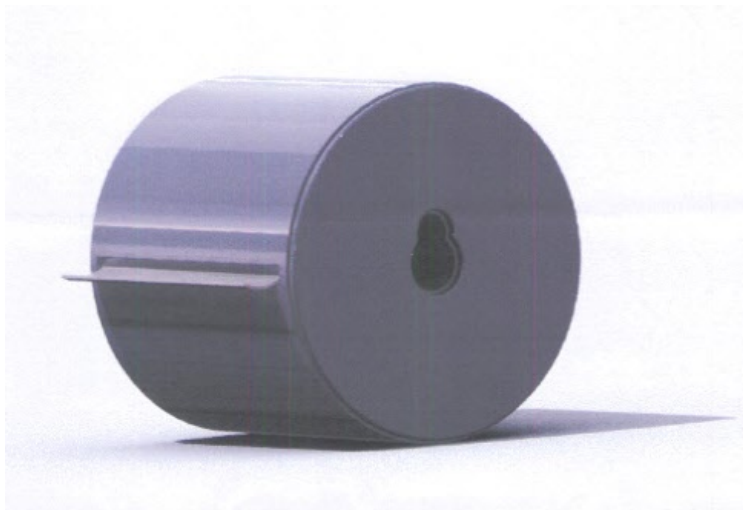

Design Text:

Wet toilet roll dispenser

Proprietor:

Behrooz Samandi

Agent:Behrooz Samandi

Registration Date: 18 August 2011

LOC (07) Cl. 23-02

4021323

Grant Date 13 September 2011



Design Text:

Detachable wallmounted bookholder/sheet holder

Proprietor:

Martin Leth Andersen

Agent:Martin Leth Andersen

Registration Date: 19 August 2011

LOC (07) Cl. 06-04

4021305

Grant Date 13 September 2011



Design Text:

Underwear

Proprietor:

University of Manchester

Agent:Geof Wolfenden

Registration Date: 19 August 2011

LOC (07) Cl. 02-01

4021324

Grant Date 13 September 2011

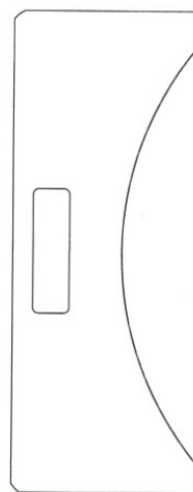

Design Text:

Vehicle wheel/alloy re-spray tyre guard

Proprietor:

David Cogan

Agent:David Cogan

Registration Date: 19 August 2011

LOC (07) Cl. 12-16

4021326

Grant Date 13 September 2011

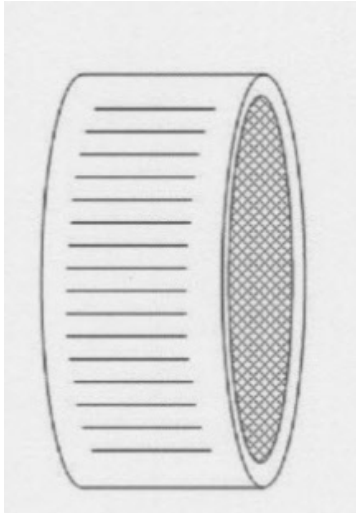

Design Text:

File ring

Proprietor:

R Hodgkinson

Agent:R Hodgkinson

Registration Date: 20 August 2011

LOC (07) Cl. 08-05

4021329

Grant Date 13 September 2011



Design Text:

Stool/seat (secco stool)

Proprietor:

Julio Tafari Dunbar

Agent:Julio Tafari Dunbar

Registration Date: 20 August 2011

LOC (07) Cl. 01-06

4021327

Grant Date 13 September 2011

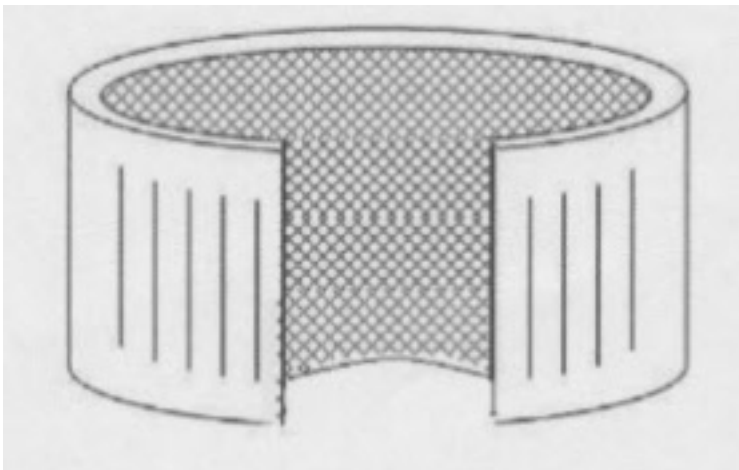

Design Text:

Open jaw file ring

Proprietor:

R Hodgkinson

Agent:R Hodgkinson

Registration Date: 20 August 2011

LOC (07) Cl. 08-05

4021330

Grant Date 13 September 2011

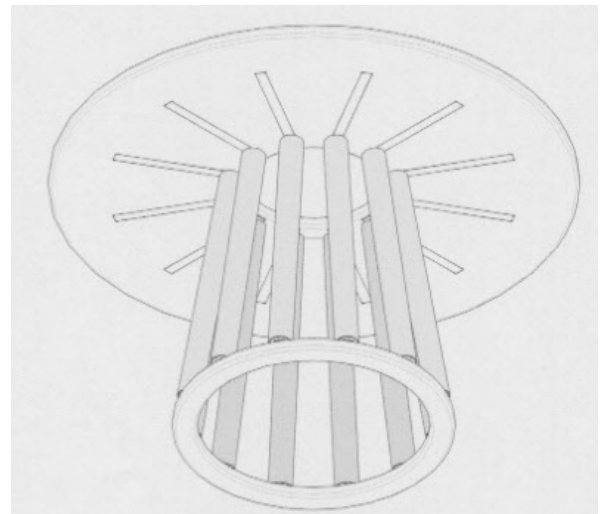

Design Text:

Table (crown table)

Proprietor:

Julio Tafari Dunbar

Agent:Julio Tafari Dunbar

Registration Date: 20 August 2011

LOC (07) Cl. 06-03

4021331

Grant Date 13 September 2011

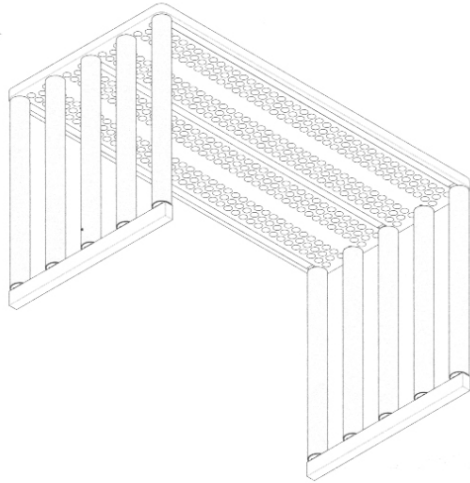

Design Text:

Desk (colonnade desk)

Proprietor:

Julio Tafari Dunbar

Agent:Julio Tafari Dunbar

Registration Date: 20 August 2011

LOC (07) Cl. 06-03

4021333

Grant Date 13 September 2011



Design Text:

Tee shirts, posters, signs

Proprietor:

George Anthony Barnes

Agent:George Anthony Barnes

Registration Date: 20 August 2011

LOC (07) Cl. 20-03

4021332

Grant Date 13 September 2011



Design Text:

Tee shirts, posters, signs

Proprietor:

George Anthony Barnes

Agent:George Anthony Barnes

Registration Date: 20 August 2011

LOC (07) Cl. 20-03

4021355

Grant Date 13 September 2011



Design Text:

Carp fishing trolley

Proprietor:

Michael Barry Peck

Agent:Michael Barry Peck

Registration Date: 23 August 2011

LOC (07) Cl. 12-02

4018412

Grant Date 14 September 2011

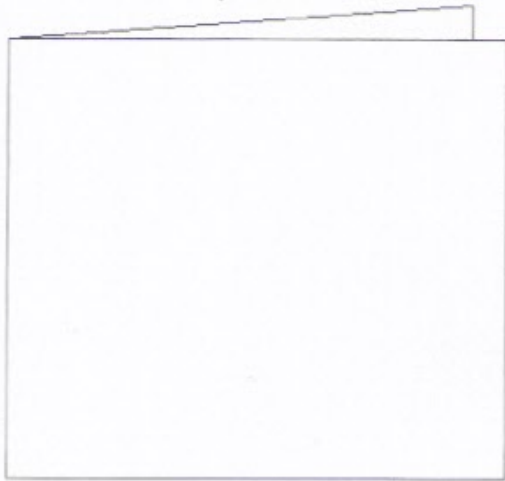

Design Text:

Gift card

Proprietor:

Ms Jane Pakenham-Byrne

Agent: Andrew Barry Bridle

Registration Date: 19 January 2011

LOC (07) Cl. 19-01

4021321

Grant Date 14 September 2011



Design Text:

Bird feeder

Proprietor:

Jeremy Levick

Agent: Jeremy Levick

Registration Date: 19 August 2011

LOC (07) Cl. 30-03

4021283

Grant Date 14 September 2011

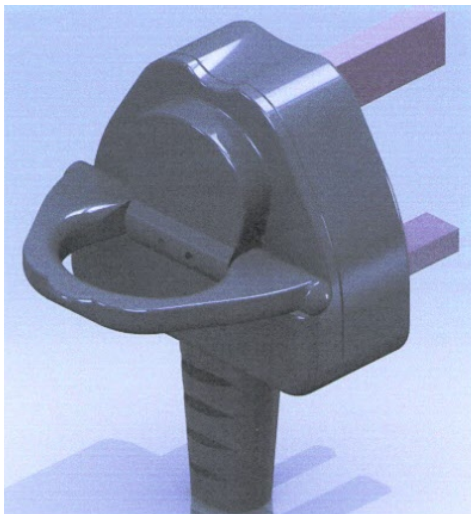

Design Text:

Electric plug

Proprietor:

ENOW Ltd

Agent: ENOW Ltd

Registration Date: 16 August 2011

LOC (07) Cl. 13-03

4021322

Grant Date 14 September 2011

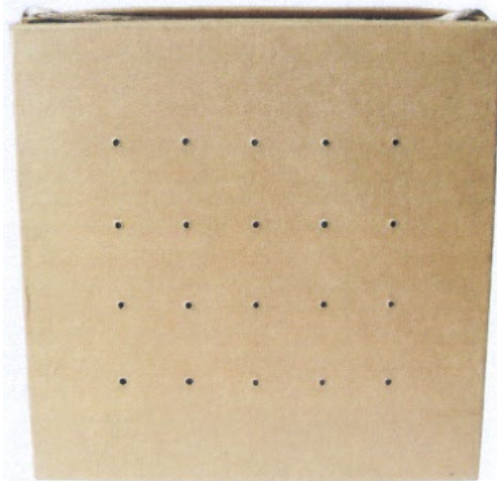

Design Text:

Feeder

Proprietor:

Jeremy Levick

Agent: Jeremy Levick

Registration Date: 19 August 2011

LOC (07) Cl. 30-03

4021325

Grant Date 14 September 2011

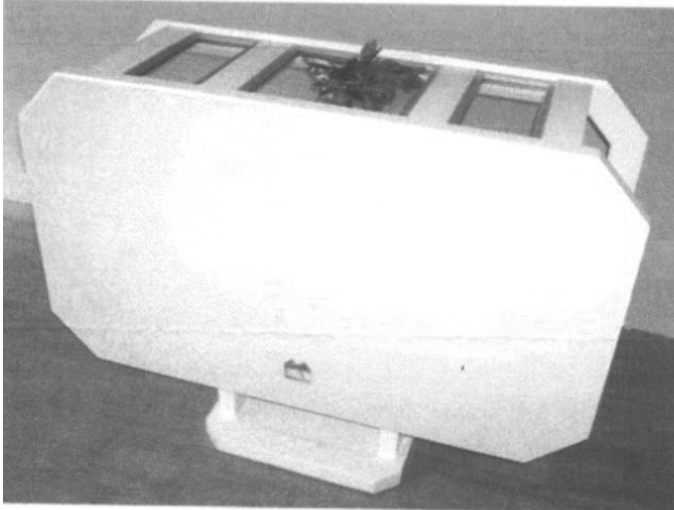

Design Text:

Storage furniture

Proprietor:

Randall Decourcy Hewitt

Agent: Randall Decourcy Hewitt

Registration Date: 20 August 2011

LOC (07) Cl. 06-04

4021364

Grant Date 15 September 2011



Design Text:

Tacpad frontline

Proprietor:

James Stephen Nicholl

Agent: James Stephen Nicholl

Registration Date: 24 August 2011

LOC (07) Cl. 19-04

4021363

Grant Date 15 September 2011

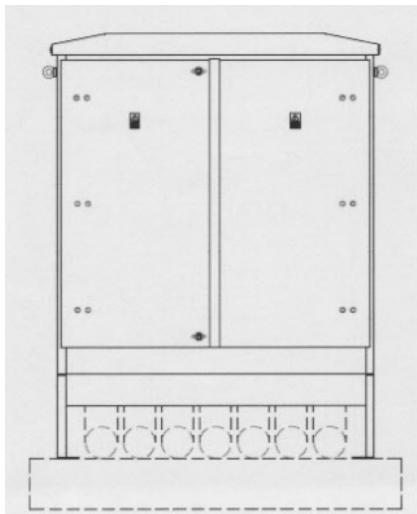

Design Text:

A feeder pillar

Proprietor:

Charles Endirect Ltd

Agent: Agile IP LLP

Registration Date: 24 August 2011

LOC (07) Cl. 13-03

4021369

Grant Date 15 September 2011



Design Text:

Buttles

Proprietor:

Alpla UK Ltd

Agent: Alpla UK Ltd

Registration Date: 24 August 2011

LOC (07) Cl. 09-01

4021370

Grant Date 15 September 2011

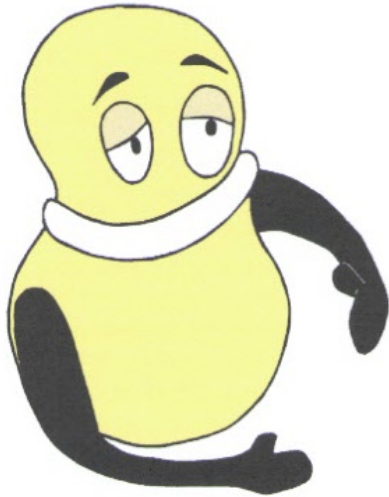

Design Text:

Cartoon character

Proprietor:

Peter Michael Stagg

Agent: Peter Michael Stagg

Registration Date: 24 August 2011

LOC (07) Cl. 99-00

4021375

Grant Date 15 September 2011



Design Text:

Graphic symbols

Proprietor:

ITV Studios Limited

Agent: Olswang LLP

Registration Date: 25 August 2011

LOC (07) Cl. 99-00

4021374

Grant Date 15 September 2011

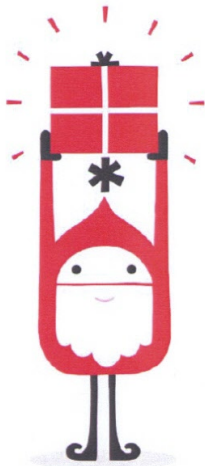

Design Text:

Graphic symbols

Proprietor:

ITV Studios Limited

Agent: Olswang LLP

Registration Date: 25 August 2011

LOC (07) Cl. 99-00

4021376

Grant Date 15 September 2011

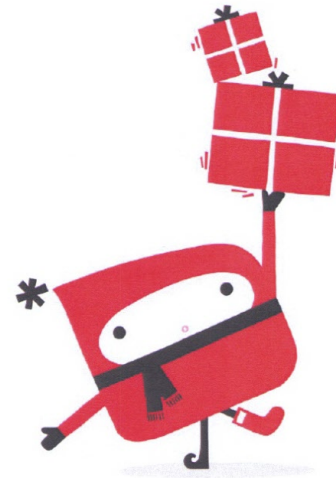

Design Text:

Graphic symbols

Proprietor:

ITV Studios Limited

Agent: Olswang LLP

Registration Date: 25 August 2011

LOC (07) Cl. 99-00

4021377

Grant Date 15 September 2011



Design Text:

Graphic symbols

Proprietor:

ITV Studios Limited

Agent:Olswang LLP

Registration Date: 25 August 2011

LOC (07) Cl. 99-00

4021379

Grant Date 15 September 2011



Design Text:

Graphic symbols

Proprietor:

ITV Studios Limited

Agent:Olswang LLP

Registration Date: 25 August 2011

LOC (07) Cl. 99-00

4021378

Grant Date 15 September 2011



Design Text:

Graphic symbols

Proprietor:

ITV Studios Limited

Agent:Olswang LLP

Registration Date: 25 August 2011

LOC (07) Cl. 99-00

4021380

Grant Date 15 September 2011



Design Text:

Graphic symbols

Proprietor:

ITV Studios Limited

Agent:Olswang LLP

Registration Date: 25 August 2011

LOC (07) Cl. 99-00

4021381

Grant Date 15 September 2011



Design Text:

Graphic symbols

Proprietor:

ITV Studios Limited

Agent:Olswang LLP

Registration Date: 25 August 2011

LOC (07) Cl. 99-00

4021391

Grant Date 15 September 2011

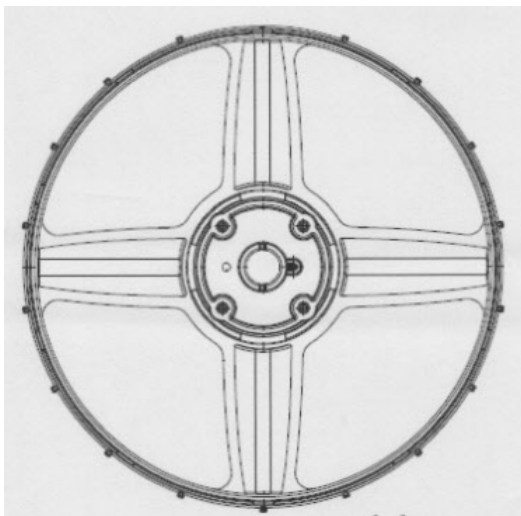

Design Text:

Golf trolley wheel

Proprietor:

Golf Innovations Ltd

Agent:Golf Innovations Ltd

Registration Date: 24 August 2011

LOC (07) Cl. 12-02

Designs Extended

The designs listed below have been renewed for further periods of five years each, by payment of the appropriate fee.

Second Period

3022743 3025489 3025805
3026020 3026021 3026093
4000617 4000619 4000624

Third Period

2104634 2104674 2104675
2104676 2104710 2104714
2104722 2104736 2104737
2104738 2104739 2104740
2104753 2104754 2104755
2104770 2104775 2104776
2104868 2104927 2105186
2105385 2105476 2105477
2106077 2106149 2106340
2106525 2106932 2106982
2106983 2106987 2106988
2106989 2106990 3001959
3001960

Fourth Period

2059141 2059229 2059495
2059577 2059611

Fifth Period

2014083 2018260